



# **Handheld Thermography Camera**

**M Series User Manual**

## Legal Information

©2022 Hangzhou Microimage Software Co., Ltd. All rights reserved.

### About this Manual

The Manual includes instructions for using and managing the Product. Pictures, charts, images and all other information hereinafter are for description and explanation only. The information contained in the Manual is subject to change, without notice, due to firmware updates or other reasons. Please find the latest version of this Manual at the HIKMICRO website ( <http://www.hikmicrotech.com> ).

Please use this Manual with the guidance and assistance of professionals trained in supporting the Product.

### Trademarks

 **HIKMICRO** and other HIKMICRO's trademarks and logos are the properties of HIKMICRO in various jurisdictions.

Other trademarks and logos mentioned are the properties of their respective owners.

### Disclaimer

TO THE MAXIMUM EXTENT PERMITTED BY APPLICABLE LAW, THIS MANUAL AND THE PRODUCT DESCRIBED, WITH ITS HARDWARE, SOFTWARE AND FIRMWARE, ARE PROVIDED "AS IS" AND "WITH ALL FAULTS AND ERRORS". HIKMICRO MAKES NO WARRANTIES, EXPRESS OR IMPLIED, INCLUDING WITHOUT LIMITATION, MERCHANTABILITY, SATISFACTORY QUALITY, OR FITNESS FOR A PARTICULAR PURPOSE. THE USE OF THE PRODUCT BY YOU IS AT YOUR OWN RISK. IN NO EVENT WILL HIKMICRO BE LIABLE TO YOU FOR ANY SPECIAL, CONSEQUENTIAL, INCIDENTAL, OR INDIRECT DAMAGES, INCLUDING, AMONG OTHERS, DAMAGES FOR LOSS OF BUSINESS PROFITS, BUSINESS INTERRUPTION, OR LOSS OF DATA, CORRUPTION OF SYSTEMS, OR LOSS OF DOCUMENTATION, WHETHER BASED ON BREACH OF CONTRACT, TORT (INCLUDING NEGLIGENCE), PRODUCT LIABILITY, OR OTHERWISE, IN CONNECTION WITH THE USE OF THE PRODUCT, EVEN IF HIKMICRO HAS BEEN ADVISED OF THE POSSIBILITY OF SUCH DAMAGES OR LOSS.

YOU ACKNOWLEDGE THAT THE NATURE OF THE INTERNET PROVIDES FOR INHERENT SECURITY RISKS, AND HIKMICRO SHALL NOT TAKE ANY RESPONSIBILITIES FOR ABNORMAL OPERATION, PRIVACY LEAKAGE OR OTHER DAMAGES RESULTING FROM CYBER-ATTACK, HACKER ATTACK, VIRUS INFECTION, OR OTHER INTERNET SECURITY RISKS; HOWEVER, HIKMICRO WILL PROVIDE TIMELY TECHNICAL SUPPORT IF REQUIRED.

YOU AGREE TO USE THIS PRODUCT IN COMPLIANCE WITH ALL APPLICABLE LAWS, AND YOU ARE SOLELY RESPONSIBLE FOR ENSURING THAT YOUR USE CONFORMS TO THE APPLICABLE LAW. ESPECIALLY, YOU ARE RESPONSIBLE, FOR USING THIS PRODUCT IN A MANNER THAT DOES NOT INFRINGE ON THE RIGHTS OF THIRD PARTIES, INCLUDING WITHOUT LIMITATION, RIGHTS OF PUBLICITY, INTELLECTUAL PROPERTY RIGHTS, OR DATA PROTECTION AND OTHER PRIVACY RIGHTS. YOU SHALL NOT USE THIS PRODUCT FOR ANY PROHIBITED END-USES, INCLUDING THE

# Handheld Thermography Camera M Series User Manual

---

DEVELOPMENT OR PRODUCTION OF WEAPONS OF MASS DESTRUCTION, THE DEVELOPMENT OR PRODUCTION OF CHEMICAL OR BIOLOGICAL WEAPONS, ANY ACTIVITIES IN THE CONTEXT RELATED TO ANY NUCLEAR EXPLOSIVE OR UNSAFE NUCLEAR FUEL-CYCLE, OR IN SUPPORT OF HUMAN RIGHTS ABUSES.

IN THE EVENT OF ANY CONFLICTS BETWEEN THIS MANUAL AND THE APPLICABLE LAW, THE LATTER PREVAILS.

## Regulatory Information

### FCC Compliance Statement

Please take attention that changes or modification not expressly approved by the party responsible for compliance could void the user's authority to operate the equipment. This device complies with Part 15 of the FCC Rules. Operation is subject to the following two conditions:

- (1) This device may not cause harmful interference, and
- (2) This device must accept any interference received, including interference that may cause undesired operation.

Note: Due to the device size limit, the above statement may not be disclaimed on the device. This equipment complies with FCC radiation exposure limits set forth for an uncontrolled environment.

Note: This product has been tested and found to comply with the limits for a Class B digital device, pursuant to Part 15 of the FCC Rules. These limits are designed to provide reasonable protection against harmful interference in a residential installation. This product generates, uses, and can radiate radio frequency energy and, if not installed and used in accordance with the instructions, may cause harmful interference to radio communications. However, there is no guarantee that interference will not occur in a particular installation. If this product does cause harmful interference to radio or television reception, which can be determined by turning the equipment off and on, the user is encouraged to try to correct the interference by one or more of the following measures:

- Reorient or relocate the receiving antenna.
- Increase the separation between the equipment and receiver.
- Connect the equipment into an outlet on a circuit different from that to which the receiver is connected.
- Consult the dealer or an experienced radio/TV technician for help.

### EU/UKCA Conformity Statement



This product and - if applicable - the supplied accessories too are marked with "CE" and comply therefore with the applicable harmonized European standards listed under the EMC Directive 2014/30/EU, RE Directive 2014/53/EU, the RoHS Directive 2011/65/EU



This product and - if applicable - the supplied accessories too are marked with "UKCA" and comply therefore with the following directives: Radio Equipment Regulations 2017, Electromagnetic Compatibility Regulations 2016, Electrical Equipment (Safety) Regulations 2016, the Restriction of the Use of Certain Hazardous Substances in Electrical and Electronic Equipment Regulations 2012.

Restrictions in the 5 GHz band:

# Handheld Thermography Camera M Series User Manual

According to Article 10 (10) of Directive 2014/53/EU, when operating in the 5150 to 5350 MHz frequency range, this device is restricted to indoor use in: Austria (AT), Belgium (BE), Bulgaria (BG), Croatia (HR), Cyprus (CY), the Czech Republic (CZ), Denmark (DK), Estonia (EE), Finland (FI), France (FR), Germany (DE), Greece (EL), Hungary (HU), Iceland (IS), Ireland (IE), Italy (IT), Latvia (LV), Liechtenstein (LI), Lithuania (LT), Luxembourg (LU), Malta (MT), Netherlands (NL), Northern Ireland (UK(NI)), Norway (NO), Poland (PL), Portugal (PT), Romania (RO), Slovakia (SK), Slovenia (SI), Spain (ES), Sweden (SE), Switzerland (CH), and Turkey (TR).

In accordance with the Radio Equipment Regulations 2017 in the UK, the device working in the 5150 to 5350 MHz frequency range is restricted to indoor use in the United Kingdom.

Frequency Bands and Power (for CE/UKCA)

| Equipment Model | Frequency Band and Power  |
|-----------------|---|
| M20 Series      | Wi-Fi 2.4 GHz (2.4 GHz to 2.4835 GHz): 20 dBm<br>Wi-Fi 2.4 GHz (2.4 GHz to 2.4835 GHz): 20 dBm; Wi-Fi 5 GHz (5.15 GHz to 5.25 GHz): 23 dBm; Wi-Fi 5 GHz (5.25 GHz to 5.35 GHz): 23 dBm; Wi-Fi 5 GHz (5.47 GHz to 5.725GHz): 23 dBm; Wi-Fi 5 GHz (5.725 GHz to 5.85 GHz): 14 dBm |

Use the power adapter provided by a qualified manufacturer. Refer to the product specification for detailed power requirements.

Use the battery provided by a qualified manufacturer. Refer to the product specification for detailed battery requirements.



2012/19/EU (WEEE directive): Products marked with this symbol cannot be disposed of as unsorted municipal waste in the European Union. For proper recycling, return this product to your local supplier upon the purchase of equivalent new equipment, or dispose of it at designated collection points. For more information see: [www.recyclethis.info](http://www.recyclethis.info)



According to the Waste Electrical and Electronic Equipment Regulations 2013: Products marked with this symbol cannot be disposed of as unsorted municipal waste in the United Kingdom. For proper recycling, return this product to your local supplier upon the purchase of equivalent new equipment, or dispose of it at designated collection points. For more information see: [www.recyclethis.info](http://www.recyclethis.info).



2006/66/EC (battery directive): This product contains a battery that cannot be disposed of as unsorted municipal waste in the European Union. See the product documentation for specific battery information. The battery is marked with this symbol, which may include lettering to indicate cadmium (Cd), lead (Pb), or mercury (Hg). For proper recycling, return the battery to your supplier or to a designated collection point. For more information see: [www.recyclethis.info](http://www.recyclethis.info)

According to the Batteries and Accumulators (Placing on the Market) Regulations 2008 and the Waste Batteries and Accumulators Regulations 2009: This product

contains a battery that cannot be disposed of as unsorted municipal waste in the United Kingdom. See the product documentation for specific battery information. The battery is marked with this symbol, which may include lettering to indicate cadmium (Cd), lead (Pb), or mercury (Hg). For proper recycling, return the battery to your supplier or to a designated collection point. For more information see: [www.recyclethis.info](http://www.recyclethis.info).

## Industry Canada ICES-003 Compliance

This device meets the CAN ICES-003 (B)/NMB-003(B) standards requirements.

This device complies with Industry Canada licence-exempt RSS standard(s). Operation is subject to the following two conditions:

- (1) this device may not cause interference, and
- (2) this device must accept any interference, including interference that may cause undesired operation of the device.

This equipment complies with IC RSS-102 radiation exposure limits set forth for an uncontrolled environment.

- (i) The device for operation in the band 5150-5250 MHz is only for indoor use to reduce the potential for harmful interference to co-channel mobile satellite systems;
- (ii) The maximum antenna gain permitted for devices in the bands 5250-5350 MHz and 5470-5725 MHz shall comply with the e.i.r.p. limit; and
- (iii) The maximum antenna gain permitted for devices in the band 5725-5825 MHz shall comply with the e.i.r.p. limits specified for point-to-point and non point-to-point operation as appropriate.

Le présent appareil est conforme aux CNR d'Industrie Canada applicables aux appareils radioexemptés de licence. L'exploitation est autorisée aux deux conditions suivantes :

- (1) l'appareil ne doit pas produire de brouillage, et
- (2) l'utilisateur de l'appareil doit accepter tout brouillage radioélectrique subi, même si le brouillage est susceptible d'en compromettre le fonctionnement.

ce matériel est conforme aux limites de dose d'exposition aux rayonnements, CNR-102 énoncée dans un autre environnement.



- (i) Les dispositifs fonctionnant dans la bande 5150-5250 MHz sont réservés uniquement pour une utilisation à l'intérieur afin de réduire les risques de brouillage préjudiciable aux systèmes de satellites mobiles utilisant les mêmes canaux.
- (ii) Le gain d'antenne maximal autorisé pour les appareils dans les bandes 5250-5350 MHz et 5470-5725 MHz doivent respecter le pire limiter; et
- (iii) Le gain d'antenne maximal autorisé pour les appareils dans la bande 5725-5825 MHz doivent respecter le pire limites spécifiées pour le point-à-point et l'exploitation non point à point, le cas échéant.

## KC

B급 기기: 이 기기는 가정용(B급) 전자파적합기기으로써 주로 가정에서 사용하는 것을 목적으로 하며, 모든 지역에서 사용할 수 있습니다.

## Symbol Conventions

The symbols that may be found in this document are defined as follows.

| Symbol   | Description   |
|--|---|
|  <b>Danger</b>  | Indicates a hazardous situation which, if not avoided, will or could result in death or serious injury.   |
|  <b>Caution</b> | Indicates a potentially hazardous situation which, if not avoided, could result in equipment damage, data loss, performance degradation, or unexpected results. |
|  <b>Note</b>    | Provides additional information to emphasize or supplement important points of the main text.   |

## Safety Instruction

These instructions are intended to ensure that user can use the product correctly to avoid danger or property loss.

### Laws and Regulations

- Use of the product must be in strict compliance with the local electrical safety regulations.

### Transportation

- Keep the device in original or similar packaging while transporting it.
- Keep all wrappers after unpacking them for future use. In case of any failure occurred, you need to return the device to the factory with the original wrapper. Transportation without the original wrapper may result in damage on the device and the company shall not take any responsibilities.
- DO NOT drop the product or subject it to physical shock. Keep the device away from magnetic interference.

### Power Supply

- Input voltage for device should meet the Limited Power Source (5 VDC, 2 A) according to the IEC61010-1 standard. Please refer to technical specifications for detailed information.
- Make sure the plug is properly connected to the power socket.
- DO NOT connect multiple devices to one power adapter, to avoid over-heating or fire hazards caused by overload.

### Battery

- Improper use or replacement of the battery may result in explosion hazard. Replace with the same or equivalent type only. Dispose of used batteries in conformance with the instructions provided by the battery manufacturer.
- The built-in battery cannot be dismantled. Please contact the manufacture for repair if necessary.
- For long-term storage of the battery, make sure it is fully charged every half year to ensure the battery quality. Otherwise, damage may occur.
- When the device is powered off and the RTC battery is full, the time settings can be kept for 2 months.
- In the first use, power on the device and charge the RTC battery with the lithium battery for more than 8 hours.
- The lithium battery voltage is 3.7 V, and the battery capacity is 5000 mAh.
- The battery is certified by UL2054.



## Maintenance

- If the product does not work properly, please contact your dealer or the nearest service center. We shall not assume any responsibility for problems caused by unauthorized repair or maintenance.
- A few device components (e.g., electrolytic capacitor) require regular replacement. The average lifespan varies, so periodic checking is recommended. Contact your dealer for details.
- Wipe the device gently with a clean cloth and a small quantity of ethanol, if necessary.
- If the equipment is used in a manner not specified by the manufacturer, the protection provided by the device may be impaired.
- Please notice that the current limit of USB 3.0 PowerShare port may vary with the PC brand, which is likely to result in incompatibility issue. Therefore, it's advised to use regular USB 3.0 or USB 2.0 port if the USB device fails to be recognized by PC via USB 3.0 PowerShare port.
- We recommend you send the device back for calibration once a year, and please contact the local dealer for the information on maintenance points.

## Using Environment

- DO NOT expose the device to extremely hot, cold, dusty, corrosive, saline-alkali, or damp environments. Make sure the running environment meets the requirement of the device. The operating temperature shall be -10°C to 50°C (14°F to 122°F), and the operating humidity shall be 90% or less.
- This device can only be safely used in the region below 2000 meters above the sea level.
- Place the device in a dry and well-ventilated environment.
- DO NOT expose the device to high electromagnetic radiation or dusty environments.
- DO NOT aim the lens at the sun or any other bright light.
- When any laser equipment is in use, make sure that the device lens is not exposed to the laser beam, or it may burn out.
- The device is suitable for indoor conditions.
- The pollution degree is 2.
- Overvoltage category: 0 for Handheld Thermography Camera.
- Overvoltage category: II for power adapter.

## Technical Support

The <https://www.hikmicrotech.com> portal will help you as a HIKMICRO customer to get the most out of your HIKMICRO products. The portal gives you access to our support team, software and documentation, service contacts, etc.

## Emergency

- If smoke, odor, or noise arises from the device, immediately turn off the power, unplug the power cable, and contact the service center.

## Laser Light Supplement Warning



Warning: The laser radiation emitted from the device can cause eye injuries, burning of skin or inflammable substances. Prevent eyes from direct laser. Before enabling the Light Supplement function, make sure no human or inflammable substances are in front of the laser lens. The wave length is 650 nm, and the power is less than 1 mW. The laser meets the IEC60825-1:2014 standard. Laser maintenance: It is not necessary to maintain the laser regularly. If the laser does not work, the laser assembly needs to be replaced in the factory under warranty. Keep the device power off when replacing laser assembly. Caution-Use of controls or adjustments or performance of procedures other than those specified herein may result in hazardous radiation exposure.

## Manufacture Address

Room 313, Unit B, Building 2, 399 Danfeng Road, Xixing Subdistrict, Binjiang District, Hangzhou, Zhejiang 310052, China

Hangzhou Microimage Software Co., Ltd

COMPLIANCE NOTICE: The thermal series products might be subject to export controls in various countries or regions, including without limitation, the United States, European Union, United Kingdom and/or other member countries of the Wassenaar Arrangement. Please consult your professional legal or compliance expert or local government authorities for any necessary export license requirements if you intend to transfer, export, re-export the thermal series products between different countries.

# Contents

|  |           |
|--|-----------|
| <b>Chapter 1 Overview .....</b>                  | <b>1</b>  |
| 1.1 Device Description .....                     | 1         |
| 1.2 Main Function .....                          | 1         |
| 1.3 Appearance .....                             | 2         |
| <b>Chapter 2 Preparation .....</b>               | <b>5</b>  |
| 2.1 Charge Device .....                          | 5         |
| 2.1.1 Charge Device via Charging Base .....      | 5         |
| 2.1.2 Charge Device via Cable Interface .....    | 6         |
| 2.2 Power On/Off .....                           | 6         |
| 2.2.1 Set Auto Power-off Duration .....          | 7         |
| 2.3 Operation Method .....                       | 7         |
| 2.4 Menu Description .....                       | 8         |
| <b>Chapter 3 Display Settings .....</b>          | <b>9</b>  |
| 3.1 Focus Lens .....                             | 9         |
| 3.2 Set Screen Brightness .....                  | 9         |
| 3.3 Set Display Mode .....                       | 10        |
| 3.4 Set Palettes .....                           | 11        |
| 3.5 Adjust Digital Zoom .....                    | 12        |
| 3.6 Display OSD Info .....                       | 12        |
| <b>Chapter 4 Temperature Measurement .....</b>   | <b>13</b> |
| 4.1 Set Temperature Measurement Parameters ..... | 13        |
| 4.1.1 Set Unit .....                             | 14        |
| 4.2 Adjust Display Temperature Range .....       | 14        |
| 4.3 Set Temperature Measurement Rule .....       | 15        |
| 4.3.1 Set Point Rule .....                       | 15        |
| 4.3.2 Set Line Rule .....                        | 16        |

|   |           |
|---|-----------|
| 4.3.3 Set Area Rule .....   | 17        |
| 4.3.4 Delete Rules .....  | 18        |
| 4.4 Temperature Alarm .....   | 18        |
| 4.4.1 Set Alarm for Thermography Rules or Pixel-to-Pixel Thermography ..... | 18        |
| <b>Chapter 5 Picture and Video .....</b>                                    | <b>20</b> |
| 5.1 Capture Picture .....   | 20        |
| 5.2 Record Video .....  | 21        |
| 5.3 View Local Files .....  | 21        |
| 5.3.1 Manage Albums .....   | 22        |
| 5.3.2 Manage Files .....  | 23        |
| 5.4 Export Files .....  | 23        |
| <b>Chapter 6 Connect Bluetooth .....</b>                                    | <b>25</b> |
| <b>Chapter 7 Light Settings .....</b>                                       | <b>26</b> |
| 7.1 Set LED Light .....   | 26        |
| 7.2 Set Laser .....   | 26        |
| <b>Chapter 8 Connect Device to Wi-Fi .....</b>                              | <b>27</b> |
| <b>Chapter 9 Set Device Hotspot .....</b>                                   | <b>28</b> |
| <b>Chapter 10 Thermal View Mobile Client Connection .....</b>               | <b>29</b> |
| 10.1 Connect via Wi-Fi .....  | 29        |
| 10.2 Connect via Hot Spot .....   | 29        |
| <b>Chapter 11 Maintenance .....</b>   | <b>30</b> |
| 11.1 View Device Information .....  | 30        |
| 11.2 Set Date and Time .....  | 30        |
| 11.3 Upgrade Device .....   | 30        |
| 11.4 Restore Device .....   | 30        |
| 11.5 Initialize Memory Card .....   | 31        |
| 11.6 About Calibration .....  | 31        |
| <b>Chapter 12 Appendix .....</b>  | <b>32</b> |

# Handheld Thermography Camera M Series User Manual

---

|   |    |
|---|----|
| 12.1 Common Material Emissivity Reference ..... | 32 |
| 12.2 FAQ .....                                  | 32 |
| 12.3 Device Command .....                       | 33 |
| 12.4 Device Communication Matrix .....          | 33 |

# Chapter 1 Overview

## 1.1 Device Description

The handheld thermography camera is a device with both optical images and thermal images. It can do thermography, video recording, snapshot capturing, alarm, and it can connect to Wi-Fi, hotspot and Bluetooth. The built-in high-sensitivity IR detector and high-performance sensor detects the variation of temperature and measure the real-time temperature. The temperature measurement range is -20 °C to 550 °C (-4 °F to 1022 °F) with the accuracy of  $\pm 2$  °C ( $\pm 3.6$  °F) or  $\pm 2\%$  when the ambient temperature is 15°C to 35 °C (59 °F to 95 °F) and the object temperature is above 0 °C (32 °F).

The picture-in-picture technique of the camera and the fusion of optical view and thermal view, enhances the details of the images display. It supports multiple palettes and alarm types. When the detected temperature in the scene does not match with the alarm rules, the device alarms by color of the palette mode automatically. It helps to find the risky part and lower your property loss, but it can not be used for human body temperature test.

The device is easy to use, and adopts ergonomic design. It is widely applied to substations, electricity prevention detection of companies, and reconnaissance survey of construction field.

## 1.2 Main Function

### Thermography

Device detects the real-time temperature, and display it on the screen.

### Storage

Device is equipped with memory module to store videos, snapshots, and important data.

### Fusion

Device can display fusion of thermal view and optical view.

### Palette and Alarm

Device supports multiple palettes, and you can set the palette mode according to the alarm function.

### Client Software Connection

- Mobile Phone: Use HIKMICRO Viewer to view live image, capture snapshots, and record videos on your phone. You can also, analyze pictures offline, generate and share a report via the app. Scan the QR codes on the cover to download the App.
- PC: Use HIKMICRO Analyzer to analyze pictures offline professionally, and generate a custom format report on your PC. Download the client software from <https://www.hikmicrotech.com/>

## Bluetooth

Device can be connected to headset via Bluetooth, and you can hear the voice in the recording or capture.

## Digital Zoom

Device supports digital zoom from 1.0x to 8.0x.

## LED Light

LED light supplement makes the device a torch in required scenarios.

## Laser Light

Long-distance laser light supplement.

## 1.3 Appearance

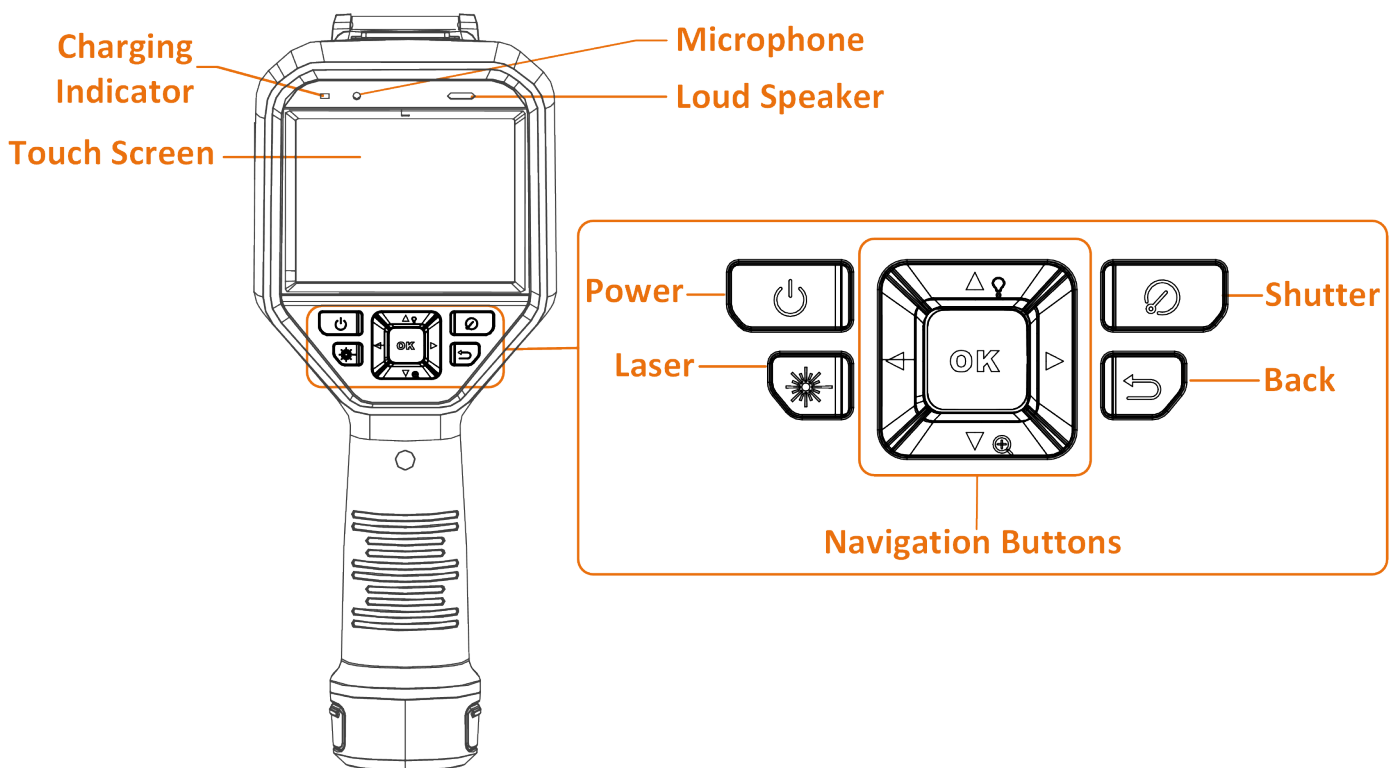

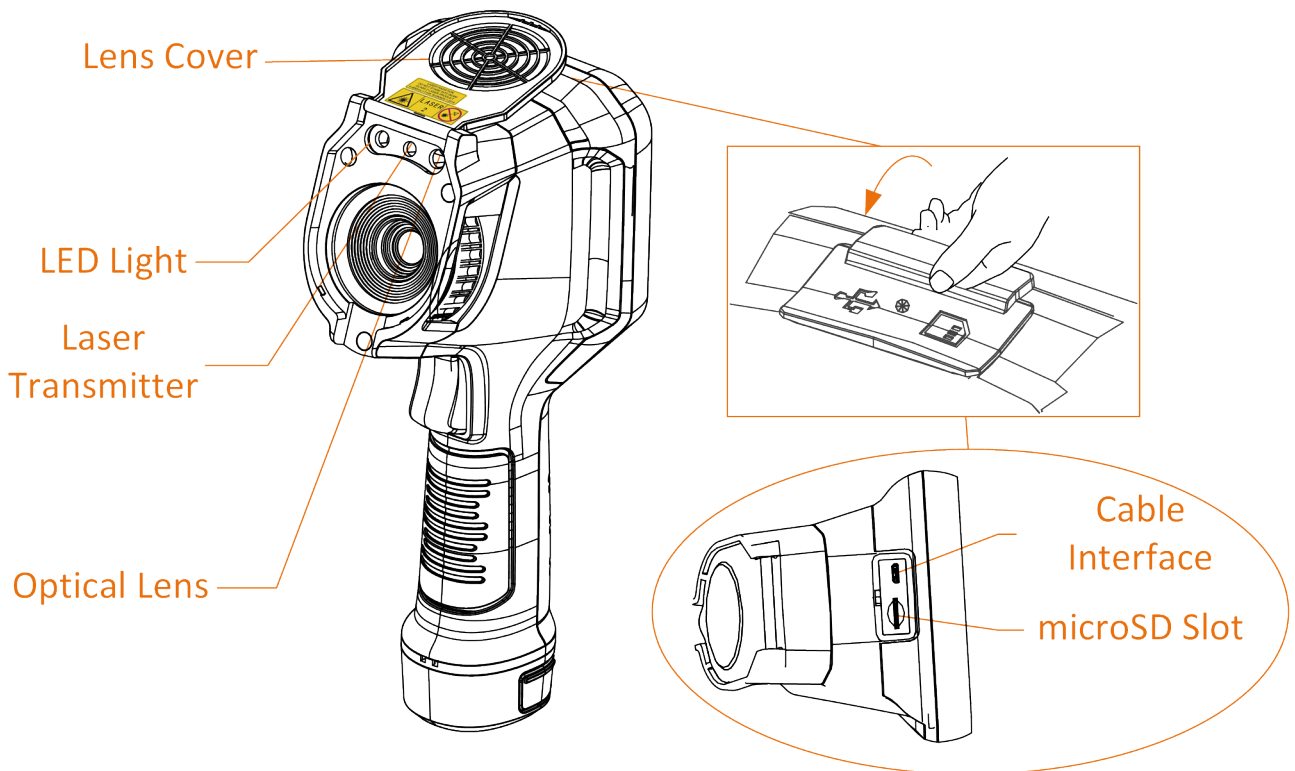
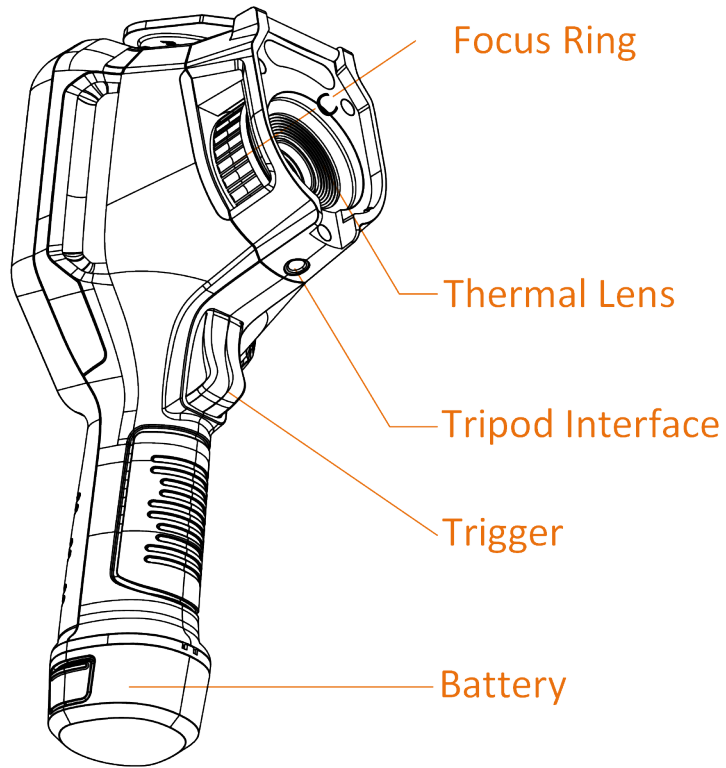





 **Note**

The appearance and function may be slightly different among models of this series.

**Figure 1-1 Appearance**

**Table 1-1 Interface Description**

| Component          | Function   |
|--------------------|--|
| Laser Button       | Hold the button to turn on laser, and release the button to turn off laser.<br><br> <b>Caution</b><br>The laser radiation emitted from the device can cause eye injuries, burning of skin or inflammable substances. Before enabling the light supplement function, make sure no human or inflammable substances are in front of the laser lens.          |
| Navigation Buttons | Menu Mode: <ul style="list-style-type: none"> <li>• Press <math>\Delta</math>, <math>\nabla</math>, <math>\triangleright</math> and <math>\triangleleft</math> to select parameters.</li> <li>• Press <math>\text{OK}</math> to confirm.</li> </ul> Non-Menu Mode: <ul style="list-style-type: none"> <li>• Press <math>\Delta</math> to turn on/off the LED light.</li> <li>• Press <math>\nabla</math> to start digital zoom.</li> </ul> |
| Shutter Button     | Cover the lens to perform the correction.  |
| Back Button        | Exit the menu or return to previous menu.  |
| Focus Ring         | Adjust image focusing. Refer to <b><i>Focus Lens</i></b> .<br><br> <b>Note</b><br>Focus adjustment may not be supported by some models.   |
| Trigger            | Pull the trigger to capture. Hold the trigger to record videos.  |
| Cable Interface    | Connect the device to your PC via cable to export files.   |

## Chapter 2 Preparation

### 2.1 Charge Device

---

 **Caution**

The built-in cell battery that powers the real time clock (RTC) of the device may drain during longtime transportation or storage. It is recommended to recharge the RTC battery for the well-functioning of the device clock.

To fully charge the RTC battery, the following requirements should be met:

- The rechargeable lithium batteries should be installed on the device.
  - The device should keep working for more than 8 hours before shutting down.
- 

#### 2.1.1 Charge Device via Charging Base

##### Steps

---

 **Note**

Please charge the device with the cable and power adapter supplied by the manufacturer (or according to the input voltage from the specifications).

---

1. Hold the device, and press both battery lock catches of the device.

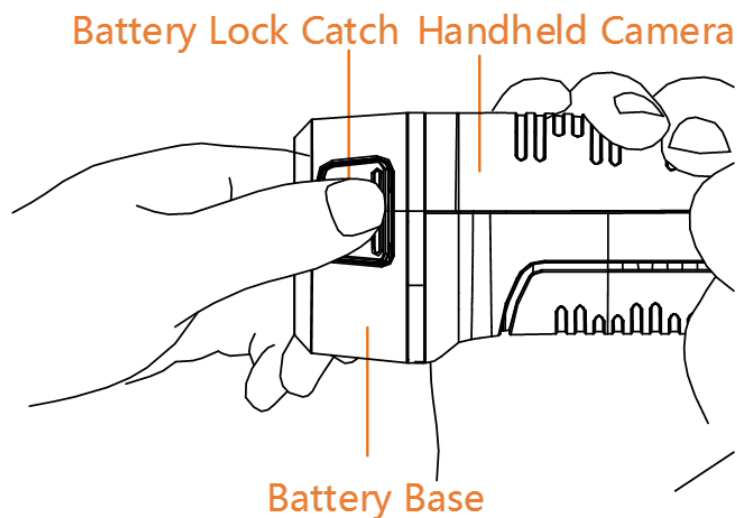

**Figure 2-1 Remove Battery**

2. Hold the lock catches, and draw the battery base to take out the battery.
  3. Insert the battery into the charging base. You can see the charging status via the pilot lamp on the charging base.
-

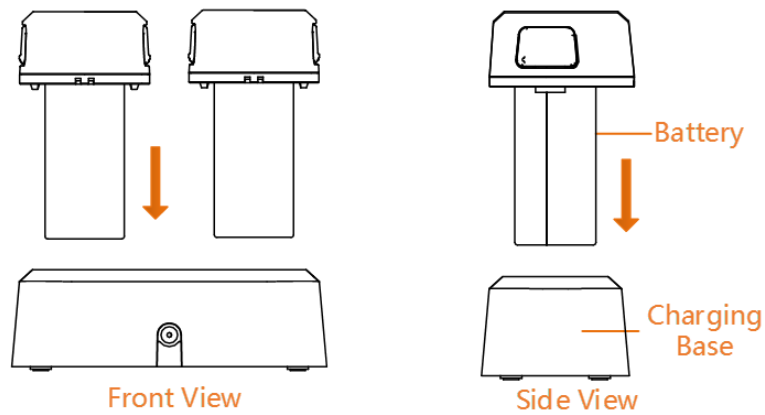

**Figure 2-2 Charge Battery**

4. When the battery is fully charged, draw the battery from the charging base.
5. Align the ribbed piece on battery with the notch of the device, and insert battery into the device.

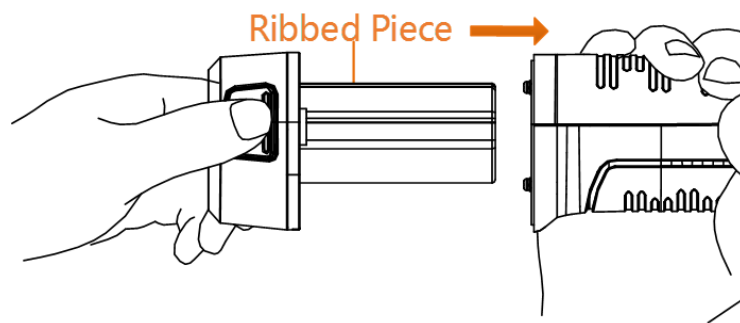

**Figure 2-3 Insert Battery**

## 2.1.2 Charge Device via Cable Interface

### Before You Start

Please make sure the battery is installed before charging.

### Steps

1. Open the top cover of the device.
2. Connect the interface and the power adaptor with Type-C or USB cable.

## 2.2 Power On/Off

## Power On

Remove the lens cover, and hold  for over three seconds to turn on the device. You can observe the target when the interface of the device is stable.

---

### Note

It may take at least 30 s until the device is ready for using when you power on it.

---

## Power Off

When the device is turned on, hold  for three seconds to power off the device.

### 2.2.1 Set Auto Power-off Duration

Go to **Local Settings** → **Device Settings** → **Auto Off** to set the automatic shutdown time for device as required.

## 2.3 Operation Method

The device supports both touch-screen control and button control.

### Touch-screen control

Tap on the screen to set parameters and configurations.

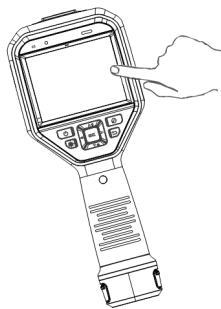

**Figure 2-4 Touch-screen Control**

### Button control

Press the navigation buttons to set parameters and configurations.

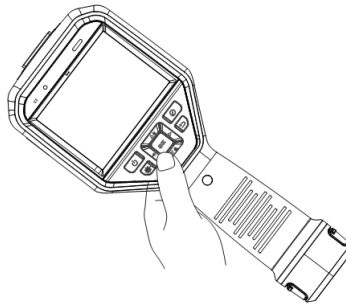

**Figure 2-5 Button Control**

- Press  $\triangle$ ,  $\nabla$ ,  $\triangleleft$ , and  $\triangleright$  to move the cursor up/down/left/right.
- Press  $\text{OK}$  to confirm.

## 2.4 Menu Description

In the observation interface, tap the screen or press  $\text{OK}$  to show the menu bar.



**Figure 2-6 Menu**

## Chapter 3 Display Settings

---

### Note

Your device will periodically perform a self-calibration to optimize image quality and measurement accuracy. In this process the image will pause briefly and you'll hear a "click" as a shutter moves in front of the detector. The self-calibration will be more frequent during start up or in very cold or hot environments. This is a normal part of operation to ensure optimum performance for your device.

---

### 3.1 Focus Lens

Adjust the lens focal length properly before you set any other configurations, or it may affect the image display and temperature accuracy.

#### Steps

1. Power on the device.
2. Aim the device lens to the appropriate scene.
3. Adjust the focus ring clockwise or anticlockwise, see figure below.

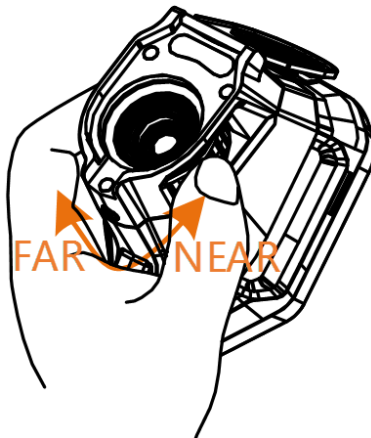

Figure 3-1 Focus Lens

### Note

DO NOT touch the lens to avoid affecting the display effect.

### 3.2 Set Screen Brightness

Go to **Settings** → **Device Settings** → **Display Brightness** to adjust the screen brightness.

## 3.3 Set Display Mode

You can set the thermal/optical view of the device. **Thermal**, **Fusion**, **PIP**, and **Optical** are selectable.

### Steps

1. Select  from the main menu.
2. Tap on the icons to select a view mode.



In thermal mode, the device displays the thermal view.



In fusion mode, the device displays the combined view of thermal channel and optical channel.



### Note

In live image, press  $\nabla$  to call fusion distance adjustment interface.  
Tap on the right distance adjustment frame and swipe to adjust the value. The image changes along with the adjusting.



Figure 3-2 Adjust Fusion Distance



In PiP (Picture in Picture) mode, the device displays thermal view inside the optical view.



### Note

In live image, press  $\nabla$  to call thermal image proportion adjustment interface.  
Tap on the right proportion adjustment frame and swipe to adjust the value. The thermal image size changes along with the adjusting.

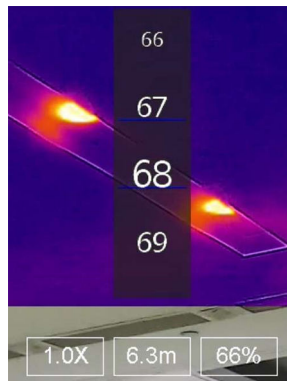

**Figure 3-3 Adjust Thermal Image Proportion**

---



In optical mode, the device displays the optical view.

3. Press  to exit.

## 3.4 Set Palettes

The palettes allow you to select the desired colors.

### Steps

1. Select  from the main menu.
2. Tap on the icons to select a palette type.

#### White Hot

The hot part is light-colored in view.

#### Black Hot

The hot part is black-colored in view.

#### Rainbow

The target displays multiple colors, it is suitable for scene without obvious temperature difference.

#### Ironbow

The target is colored as heated iron.

#### Red Hot

The hot part is red-colored in view.

#### Fusion

The hot part is yellow-colored and the cold part is purple-colored in view.

#### Rain

The hot part in the image are colored, and the else is blue.



3. Press  to exit the setting interface.

## Note

You can also press  on the live view interface to change the palettes.

---

## 3.5 Adjust Digital Zoom

In the live view interface, press  to enter the digital zoom setting interface.

Tap the zoom frame on the live image, and swipe up and down to change the zooming level. The image changes along with your operations.



Figure 3-4 Adjust Zooming

## 3.6 Display OSD Info

Go to **Settings** → **Device Settings** → **Display Settings** to enable the information on-screen display.

### Status Icon

The device status icons, for example, battery status, memory card, hotspot, etc.

### Time

Device time and date.

### Parameters

Temperature measurement parameters, for example, target emissivity, temperature unit, etc.

### Brand Logo

The brand logo is a manufacturer logo displayed on the upper right corner of the screen. You can turn it off if not needed.

## Chapter 4 Temperature Measurement

The thermography (temperature measurement) function provides the real-time temperature of the scene and display it on the left of your screen. The thermography function is turned on by default.

---

### Note

Your device will periodically perform a self-calibration to optimize image quality and measurement accuracy. In this process the image will pause briefly and you'll hear a "click" as a shutter moves in front of the detector. The self-calibration will be more frequent during start up or in very cold or hot environments. This is a normal part of operation to ensure optimum performance for your device.

---

### 4.1 Set Temperature Measurement Parameters

You can set temperature measurement parameters to improve the accuracy of temperature measurement.

#### Steps

1. Go to **Local Settings** → **Thermography Settings** .
2. Set the **Thermography Range**, **Emissivity**, etc.

#### Thermography Range

Select the temperature measurement range. The device can detect the temperature and switch thermography range automatically in **Auto Switch** mode.

#### Emissivity

Refer to ***Common Material Emissivity Reference*** to set the emissivity of your target.

---

### Note

Go to **Local Settings** → **Device Settings** → **Display Settings** to disable **Parameters** if the set emissivity is not needed to display on screen.

---

#### Reflection Temperature

If any object (not the target) of high temperature is in the scene, and the target emissivity is low, set the reflection temperature as the high temperature to correct the thermography effect.

#### Distance

The distance between the target and the device. You can customize the target distance or select the target distance as **Near**, **Middle**, or **Far**.

#### Temperature Display

Control the display of the detected min. temperature, max. temperature, or average temperature on screen and captured images.

## Humidity

Set the relative humidity of current environment.

3. Return to previous menu to save the settings.

## What to do next

---



### Note

Go to **Local Settings** → **Device Settings** → **Device Initialization** → **Measurement Tool Initialization** to initialize the temperature measurement parameters when you find the temperature measurement tool is abnormal.

---

## 4.1.1 Set Unit

Go to **Local Settings** → **Device Settings** → **Unit** to set the temperature unit and distance unit.

## 4.2 Adjust Display Temperature Range

Set a temperature section and the palette only works for targets within the temperature section. You can adjust the temperature range.



### Steps

1. Select **Level & Span**  from the main menu.
2. Select **Auto**  or **Manual** .





#### Auto Adjustment

Select . The device adjusts display temperature range according to the actual targets temperature automatically.

#### Manual Adjustment

Select , and press .

There are 2 ways to adjust the range in this mode:

- Adjust the display temperature range based on a selected area.  
Tap on an interest area of the screen. A circle is displayed around the area, and the palette temperature range readjusts to show as many details of the area as possible.
- Set the upper and lower limits of the temperature range manually.  
You can press  or , or tap on the value on screen to lock a value. And press  or , or tap on the arrows on screen to adjust the unlocked temperature value(s).

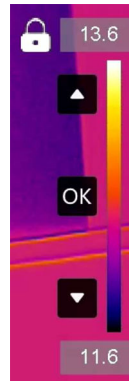

Figure 4-1 Manual Level & Span

3. Press to save settings and exit. You can also press or tap to save settings and exit.

### 4.3 Set Temperature Measurement Rule

You can set temperature measurement parameters to improve the accuracy of temperature measurement.

#### Steps

1. Select from the main menu.
2. Set the point, line, or area rules.

The configured rule numbers are displayed near the rule icon.





Figure 4-2 Temperature Measurement Rule Settings

#### 4.3.1 Set Point Rule

You can set four types of point temperature measurement rules.

Table 4-1 Icon Description

| Icon | Description                                    |
|------|--|
|      | Center Point Temperature Measurement           |
|      | High-temperature Point Temperature Measurement |

| Icon  | Description                                   |
|---|---|
|  | Low-temperature Point Temperature Measurement |
|  | Custom Point Temperature Measurement          |

The setting methods of center point, high-temperature, and low-temperature point temperature measurement are all the same. Here is the example of setting high-temperature point temperature measurement.



### Example

Tap  on the interface, the device locates the point of the highest temperature, and displays Max: XX.

## Custom Point Temperature Measurement

The device can detect the temperature of a custom point.

### Steps

1. Select .
2. Press .
3. Move the point with the navigation buttons, or tap on the touch-screen to select a point and move it.
4. Press .

The temperature of custom point (e.g. P1) displays P1: XX.

5. **Optional:** Tap the point to set the **Emissivity** and **Distance** for the rule.



### Note

If the rule-specific emissivity and distance are set, the measurement is conducted based on the parameters. Otherwise, the parameters set from **Local Settings** → **Thermography Settings** are used for measurements.

6. Repeat the above steps to set other custom points.









### Note

At most ten custom points are supported.

---

## 4.3.2 Set Line Rule

### Steps

1. Select .
2. Press  to generate a default line.
3. Move the line to the required position.
  - Tap the line, and press , , , and  to move the line up/down/left/right.

- Tap the line on touch-screen and drag it to the required position.
4. Adjust the length of the line.
    - Tap the end of the line, and press  $\Delta$ ,  $\nabla$ ,  $\triangleleft$  to extend or shorten the line.
    - Tap and drag the end of the line to extend or shorten it.
  5. **Optional:** Tap the line to set the **Emissivity** and **Distance** for the rule.
- 

### Note

If the rule-specific emissivity and distance are set, the measurement is conducted based on the parameters. Otherwise, the parameters set from **Local Settings** → **Thermography Settings** are used for measurements.

---

6. Press .
- 

### Note

Only one line is supported.

---



The maximum temperature, minimum temperature, and average temperature of the line display in the top left corner of the screen. The real-time temperature trend chart will display near the line.

### What to do next

Displayed temperature types for the rule are configurable at **Local Settings** → **Thermography Settings** → **Temperature Display**.

## 4.3.3 Set Area Rule

### Steps

1. Select .
2. Press  to generate a default frame.
3. Move the frame to the required position.
  - Tap the frame, and press  $\Delta$ ,  $\nabla$ ,  $\triangleleft$ , and  $\triangleright$  to move the frame up/down/left/right.
  - Tap and drag the frame on touch-screen to move it to the required position.
4. Adjust the size of the frame.
  - Tap one corner of the frame, and press  $\Delta$ ,  $\nabla$ ,  $\triangleleft$  to enlarge or contract the frame.
  - Tap and drag the corner of the frame on touch-screen to enlarge or contract it.
5. Press .

The maximum temperature, minimum temperature, and average temperature of the framed area are displayed on the left of the screen.

6. **Optional:** Tap the frame to set the **Emissivity** and **Distance** for the rule.
- 

### Note

If the rule-specific emissivity and distance are set, the measurement is conducted based on the parameters. Otherwise, the parameters set from **Local Settings** → **Thermography Settings** are used for measurements.

---

7. Repeat the above steps to set other areas.



## Note

At most three areas are supported.



---

### What to do next

Displayed temperature types for the rule are configurable at **Local Settings → Thermography Settings → Temperature Display** .

## 4.3.4 Delete Rules

### Delete All Rules

Tap  and press  to clear all temperature rules.

### Delete One Rule

- In the rule setting mode, tap  and choose the single rule you want to delete.
- In the observation interface, tap on a rule (point, line or frame) and enter the editing mode. Tap **Delete** to delete the rule.

## 4.4 Temperature Alarm

When the temperature of targets triggers the set alarm, the device will perform configured actions, such as, flashing the rule frame, making an audible warning, or sending notification to the client software.

### 4.4.1 Set Alarm for Thermography Rules or Pixel-to-Pixel Thermography

Alarm actions, such as, audible warning, flashing alarm, and sending notification to the client software, are triggered when the tested temperature exceeds the set alarm or alert value.

#### Steps

1. Go to **Settings → Thermography Settings → Alarm Settings** .
2. Enable the function and set the alarm threshold and alert threshold.

#### Alarm Threshold

When the tested temperature exceeds the threshold, the device sends alarm notification to the client software. It beeps if the audible warning is enabled. The frame flashes red if the frame rule is configured.

#### Alert Threshold

When the tested temperature exceeds the threshold, the device sends alert notification to the client software.

3. Set the linkage method such as audible warning and flashing alarm in **Alarm Linkage**.

### **Audible Warning**

The device beeps when target temperature exceeds the alarm threshold.

### **Flashing Alarm**

The LED light flashes when the target temperature exceeds the alarm threshold.



### **Note**

If the area rules are set to measure temperature, the alarm threshold, alert threshold and audible warning settings only works in the framed areas. Otherwise, the parameters are valid for pixel-to-pixel temperature measurement (whole-screen temperature measurement).

---



## Chapter 5 Picture and Video

Insert memory card into the device, then you can record videos, capture snapshots, and mark and save important data.

---

### Note

- Device does not support capturing or recording when the menu is shown.
  - When the device is connected to your PC, it does not support capturing or recording.
  - Go to **Local Settings** → **Device Settings** → **Filename Header** , you can set the filename header for capturing or recording to distinguish the files recorded in a specify scene.
  - Go to **Local Settings** → **Device Settings** → **Device Initialization** to initialize the memory card is needed.
- 

### 5.1 Capture Picture

#### Before You Start

- A memory card should be mounted for picture storage.
- In the live view interface, press  $\Delta$  to enable the LED light in dark environment.





#### Steps

1. Go to **Local Settings** → **Capture Settings** .
2. Select **Photo Settings** to set the capture mode.

**Single Capture**            Capture one picture for one time.

**Continuous Capture**    Capture multiple pictures for one time. You can set the amount of pictures.

**Timed Capture**            Device captures one picture after the specified time interval. You can set the time interval as needed.

3. **Optional:** Set **Visible Image Resolution** for the captured optical image as needed.
4. **Optional:** Enable **Save Optical Picture**, if you want to save additional optical images when you triggers captures in thermal, PIP, or fusion mode.
5. Press  to exit.
6. In the live view interface, pull the trigger to capture snapshot.
7. The captured image is displayed on the right of the live view interface. Tap the image to start edition.
  - 1) Tap  to add text remarks. A soft keyboard is displayed, and you can enter the comment and confirm.
  - 2) Tap  to add voice remarks. Hold  to start recording and release the button to stop recording.
  - 3) Pull the trigger to save the snapshot.

---

## Note

You can also press  to quit the saving.

---

### What to do next

Tap  in menu mode to check saved pictures. See [View Local Files](#) for more information.



## 5.2 Record Video

### Steps

1. In the live view interface, pull the trigger to start recording. The recording icon and recording time display are displayed in the interface.
2. When you finish, pull the trigger again to stop recording. The recording video will be saved automatically.

---

## Note

You can also press  or  to stop recording.









---

### What to do next

Check the saved videos from  in menu mode. See [View Local Files](#) for more information.

## 5.3 View Local Files





### Steps

1. Select  from the main menu.
2. Press  and  to select an album.
3. Press , , , and  to select a video clip or snapshot.
4. Press  to view the file.

**Table 5-1 File Type and Description**

| File Type                        | Description  |
|----------------------------------|--|
| MP4 videos, format .mp4          | Videos of this format can be played on local device, or exported to play by any other supported player.<br>But, this format can not be played by HIKMICRO Analyzer |
| Radiometric images, format .jpeg | Images can be viewed on local device, or exported and analyzed in HIKMICRO Analyzer.   |

 **Note**









- Files are arranged in chronological order, with the most recent at the top. If you fails to find the most recently taken snapshots or videos, please check the time and date settings of your device. See ***Set Date and Time*** for instructions.
- When you are viewing files, you can switch to other files by pressing  and  or tapping  and  on the interface.
- When you are viewing snapshots with voice notes, You can tap  to play the sound. If you want to listen to the recorded sound in MP4 videos or with snapshots by bluetooth earphones or speakers, see ***Connect Bluetooth*** for instructions.
- For file exporting, see ***Export Files*** for instructions.
- For file analysis, download HIKMICRO Analyzer from our website <https://www.hikmicrotech.com/>.





**What to do next**

For file management, see ***Manage Files*** for instructions; for album management, see ***Manage Albums*** for instructions.

### 5.3.1 Manage Albums





The recorded image/video files are saved in the albums. You can create new albums, rename an album, change the default album, and delete albums.

| Task                            | Operations  |
|---------------------------------|---|
| Create a New Album              | a. Select  from the main menu.<br>b. Tap  .<br>c. Enter an album name by the soft keyboard.<br>d. Tap  to finish.<br><br> <b>Note</b><br>The newly created album becomes the default saving album and appears at the top of the album list. |
| Rename an Album                 | a. Select  from the main menu.<br>b. Tap to select the album to rename.<br>c. Tap  , and select <b>Rename</b> . A soft keyboard is displayed.<br>d. Delete the old name, and enter the new name.<br>e. Tap  to finish.   |
| Change the Default Saving Album | a. Select  from the main menu.<br>b. Select the album you want to use as the default saving album.<br>c. Tap  , and select <b>Set as Default Saving Album</b> .   |



| Task            | Operations  |
|-----------------|---|
|                 |  <b>Note</b><br>The default saving album appears at the top of the album list.   |
| Delete an Album | a. Select  from the main menu.<br>b. Tap to select the album to delete.<br>c. Tap  , and select <b>Delete</b> .<br><br> <b>Note</b><br>The files in an album are deleted as well when deleting the album. Move the files to other albums if they are still needed. See <a href="#">Manage Files</a> for instructions.<br>d. Tap <b>OK</b> to delete the album. |

## 5.3.2 Manage Files

You can delete the recorded files and move the files to other albums on the device.

| Task           | Operations  |
|----------------|---|
| Delete File(s) | a. Select  from the main menu.<br>b. Tap to select the album storing the file(s) to be deleted.<br>c. In the album, tap  , and select one or more files to be deleted.<br>d. Tap <b>Delete</b> .<br>e. Tap <b>OK</b> to delete the file(s).                       |
| Move File(s)   | a. Select  from the main menu.<br>b. Tap to select the album storing the file(s) to be moved.<br>c. In the album, tap  , and select one or more files to be moved.<br>d. Tap <b>Move</b> . The album list is displayed.<br>e. Tap to select the album to move to. |

### Note

Tap  to select all files, and tap  to cancel the selection.

---

## 5.4 Export Files

Connect the device to your PC with supplied cable, you can export the recorded videos and captured snapshots.

### Steps

1. Open the cover of cable interface.
2. Connect the device to your PC with cable and open the detected disk.
3. Select and copy the videos or snapshots to PC to view the files.
4. Disconnect the device from your PC.



### Note

For the first time connection, the driver will be installed automatically.

---



### What to do next

You can import the captured snapshots to HIKMICRO Analyzer for further data analysis. See the *User Manual of HIKMICRO Analyzer* (embedded in the client software, **Help → User Manual**) for the operation guide.

## Chapter 6 Connect Bluetooth

You can use the bluetooth headset to play the audio recorded together with the videos and the images.

### Steps

1. Select  from the main menu.
2. Go to **Local Settings** → **Connect** → **Bluetooth** .
3. Tap on  to enable the bluetooth.

---

### Note

You can also press  or **OK** to quit pairing.

---

The device will search the nearby enabled bluetooth headsets and pair them automatically.

## Chapter 7 Light Settings

### 7.1 Set LED Light

Press  in the live view to turn on/off the LED light.

### 7.2 Set Laser

In the live view interface, hold  to enable/disable the laser light.

---

#### **Caution**

The laser radiation emitted from the device can cause eye injuries, burning of skin or inflammable substances. Before enabling the Light Supplement function, make sure no human or inflammable substances are in front of the laser lens.

---

## Chapter 8 Connect Device to Wi-Fi

### Steps

1. Go to **Settings** → **Connect** → **WLAN** .
2. Tap  to enable Wi-Fi, and the searched Wi-Fi will be listed.

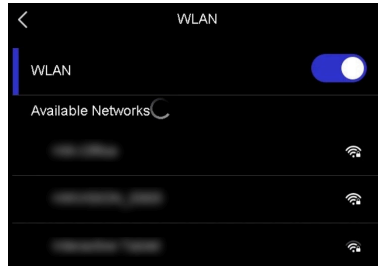

**Figure 8-1 Wi-Fi List**

3. Select Wi-Fi to connect to and a soft keyboard is displayed.
4. Enter the password.
5. Tap  to hide the keypad and connect Wi-Fi.

---

### **Note**

- DO NOT tap **space**, or the password may be incorrect.
  - Leaving the Wi-Fi setting interface does not interrupt the connection.
- 

### Result

A Wi-Fi icon shows on the main interface when the connection is completed.



## Chapter 9 Set Device Hotspot

With the device hotspot, other equipment with Wi-Fi function can join the device for data transmission.

### Steps

1. Go to **Settings** → **Connect** → **Hotspot** .
2. Tap  to enable hotspot function.
3. Tap **Set Hot Spot**. A soft keyboard is displayed.

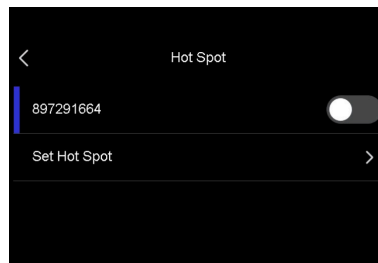

**Figure 9-1 Set Hot Spot**

4. Set the password for the hotspot by touch the screen.

---

### **Note**

- When setting the password, do not tap **space**, or the password may be incorrect.
- The password should be at least 8 digits, consisting of numbers and characters.

5. Tap  to save.

## Chapter 10 Thermal View Mobile Client Connection

The device supports both Wi-Fi connection and hot spot. Connect the device to HIKMICRO Viewer, and you can control the device via mobile client.

### 10.1 Connect via Wi-Fi

#### Before You Start

Download and install HIKMICRO Viewer on your phone.

#### Steps

1. Connect your device to a Wi-Fi network. See [Connect Device to Wi-Fi](#) for instructions.
2. Connect your phone to the Wi-Fi network that the device is in.
3. Launch the app and follow the startup wizard to create, and register an account.
4. Search and add the device to the mobile client.

#### Result

You can view the live view, capture snapshots, and record videos via the client.

### 10.2 Connect via Hot Spot

#### Before You Start

Download and install HIKMICRO Viewer on your phone.

#### Steps

1. Turn on the device hop spot and complete hot spot settings. See [Set Device Hotspot](#) for instructions.
2. Connect your phone to the Hot Spot of the device.
3. Launch the app and follow the startup wizard to create, and register an account.
4. Search and add the device to the mobile client.

#### Result

You can view the live view, capture snapshots, and record videos via the client.

## Chapter 11 Maintenance

### 11.1 View Device Information

Go to **Local Settings** → **Device Settings** → **Device Information** to view the device information.

### 11.2 Set Date and Time

#### Steps

1. Go to **Local Settings** → **Device Settings** → **Time and Date** .
2. Set the date and time.
3. Press  to save and exit.



Go to **Local Settings** → **Device Settings** → **Display Settings** to enable or disable time and date display.

---

### 11.3 Upgrade Device

#### Steps

1. Connect the device to your PC with cable and open the detected disk.
2. Copy the upgrade file and paste it to the root directory of the device.
3. Disconnect the device from your PC.
4. Reboot the device and then it will upgrade automatically. The upgrading process will be displayed in the main interface.



After upgrading, the device reboots automatically. You can view the current version in **Local Settings** → **Device Information** .

---

### 11.4 Restore Device

Go to **Local Settings** → **Device Settings** → **Device Initialization** to initialize the device and restore default settings.

## 11.5 Initialize Memory Card

When a memory card is use on the handheld thermal camera for the first time, it needs to be initialized first.

Go to **Local Settings → Device Settings → Device Initialization** to initialize the memory card.

---



### **Caution**

If there are files in the memory card, make sure that the files has been backed up before memory card initialization. Once the card is initialized, data and files can not be recovered.

---

## 11.6 About Calibration

We recommend you send the device back for calibration once a year, and please contact the local dealer for the information on maintenance points. For more detailed calibration services, please refer to <https://www.hikmicrotech.com/en/calibrationservices/2> .

## Chapter 12 Appendix

### 12.1 Common Material Emissivity Reference

| Material              | Emissivity |
|-----------------------|------------|
| Human Skin            | 0.98       |
| Printed Circuit Board | 0.91       |
| Concrete              | 0.95       |
| Ceramic               | 0.92       |
| Rubber                | 0.95       |
| Paint                 | 0.93       |
| Wood                  | 0.85       |
| Pitch                 | 0.96       |
| Brick                 | 0.95       |
| Sand                  | 0.90       |
| Soil                  | 0.92       |
| Cloth                 | 0.98       |
| Hard Paperboard       | 0.90       |
| White Paper           | 0.90       |
| Water                 | 0.96       |

### 12.2 FAQ

Scan the following QR code to get device common FAQ.



## 12.3 Device Command

Scan the following QR code to get device common serial port commands.

Note that the command list contains the commonly used serial port commands for HIKMICRO thermal cameras.



## 12.4 Device Communication Matrix

Scan the following QR code to get device communication matrix.

Note that the matrix contains all communication ports of HIKMICRO thermal cameras.





**HIKMICRO**

See the World in a New Way